

# SOLAR POST CAP

UB-350-400-X

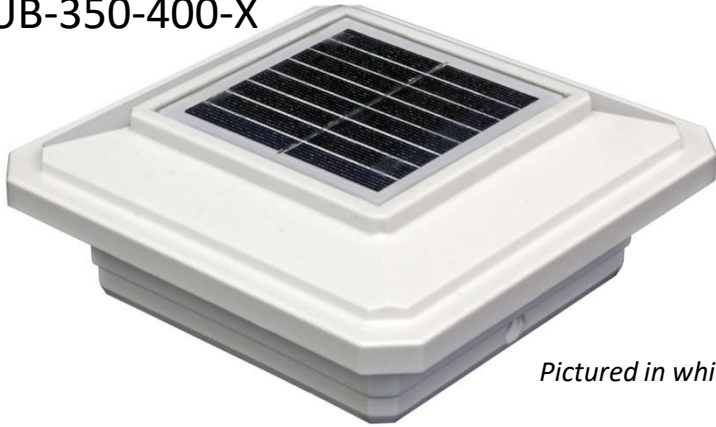

*Pictured in white*

See [www.ultrabrighttech.com](http://www.ultrabrighttech.com) for other color & size options

## Solar Post Cap:

Ultra Bright's **Solar Post Cap Light** is the most advanced, powerful, robust, solar fence post light available. Add safety, elegance and ambience to your deck without the hassle of electrical wiring! Patented magnet technology allows users to easily adjust between 7-brightness levels to meet seasonal performance, brightness, & run preference.

Each side of the light has 12 white ultra-high intensity downward shining LEDs that automatically turn on at dusk and turn off at dawn. Swipe the magnet quickly over the solar panel to adjust between 7 brightness levels or "OFF".



4-Season Rated



PATENTED DESIGN



Copyright Protected Design

### LIGHT CHARACTERISTICS

Light Source	12 Ultra-High Intensity White LEDs
Lumens output	5 -35 Lumens *Varies with Brightness Levels
Available LED Colors	White
Light Mode	Constant * Variable Brightness
Visible Range	100m-200m+
Horizontal Output (degrees)	360°
Vertical Divergence (degrees)	180°
LED Life Expectancy (hours)	> 100,000 hrs

### ELECTRICAL CHARACTERISTICS

Circuit Protection	Integrated / Overcharge / Over Discharge / Constant Current
Nominal Voltage (v)	3.2v Battery, 4v Solar
Power / Brightness Levels	7 Levels, User Adjustable with Magnet
Autonomy (hours)	10-140hrs *On full Charge * Varies with Brightness Setting
Temperature Range	14-158° Fahrenheit

### SOLAR CHARACTERISTICS

Solar Module Type	Tempered Glass + Monocrystalline Cell
Power (watts)	0.8 Watts
Solar Module Efficiency (%)	18 % Super High Efficiency Cells

### POWER SUPPLY

Battery Type	NiMh
Battery Size	2pcs AA 1.2v
Battery Capacity (mAh)	1200 mA
Nominal Voltage (v)	2.4v (2pcs 1.2v AA Batteries)
Battery Service Life	1-3 years *(Varies with local Environment)
Battery Service Access	Yes: User Changeable / Replaceable

### PHYSICAL CHARACTERISTICS

Body Material	High Performance ASA
Lens Material	Bayer UV Stabilized Poly Carbonate
External Lens Design	Smooth / Clear
Internal Lens design	NA
Water Proof Rating	IP 68

- Base Options: (Post Sizes)
- 4.00"x4.00" – (Generic/Vinyl)
  - 3.5"x3.5" – (Generic/Wood)

Height	2.55" (65mm)
Width / Width	5.5" x 5.5" (140mm)
Weight	1.10 lbs / (0.50 kg)

### OTHER

Other Options & Sizes	Please Contact
1yr Limited Warranty	* Information subject to change without notice



Ultra Bright Tech  
P.O. Box 414  
105 W. Simon St.  
Laotto, IN 46763

Phone: 260-918-2758  
Fax: 260-918-3540  
E-mail [sales@ultrabrighttech.com](mailto:sales@ultrabrighttech.com)  
Web: [www.ultrabrighttech.com](http://www.ultrabrighttech.com)

# SOLAR POST CAP

- ✔ 4-10X More Powerful Solar Panel
- ✔ 5-20X Brighter Light
- ✔ 10x Longer Service Life
- ✔ 7 Adjustable Brightness Levels
- ✔ IP 68 Waterproof Electronics
- ✔ 12 Ultra Bright White LEDs

\* NOTE: Information is a general reference in comparison to the best solar fence post lights we were able to find on the market.

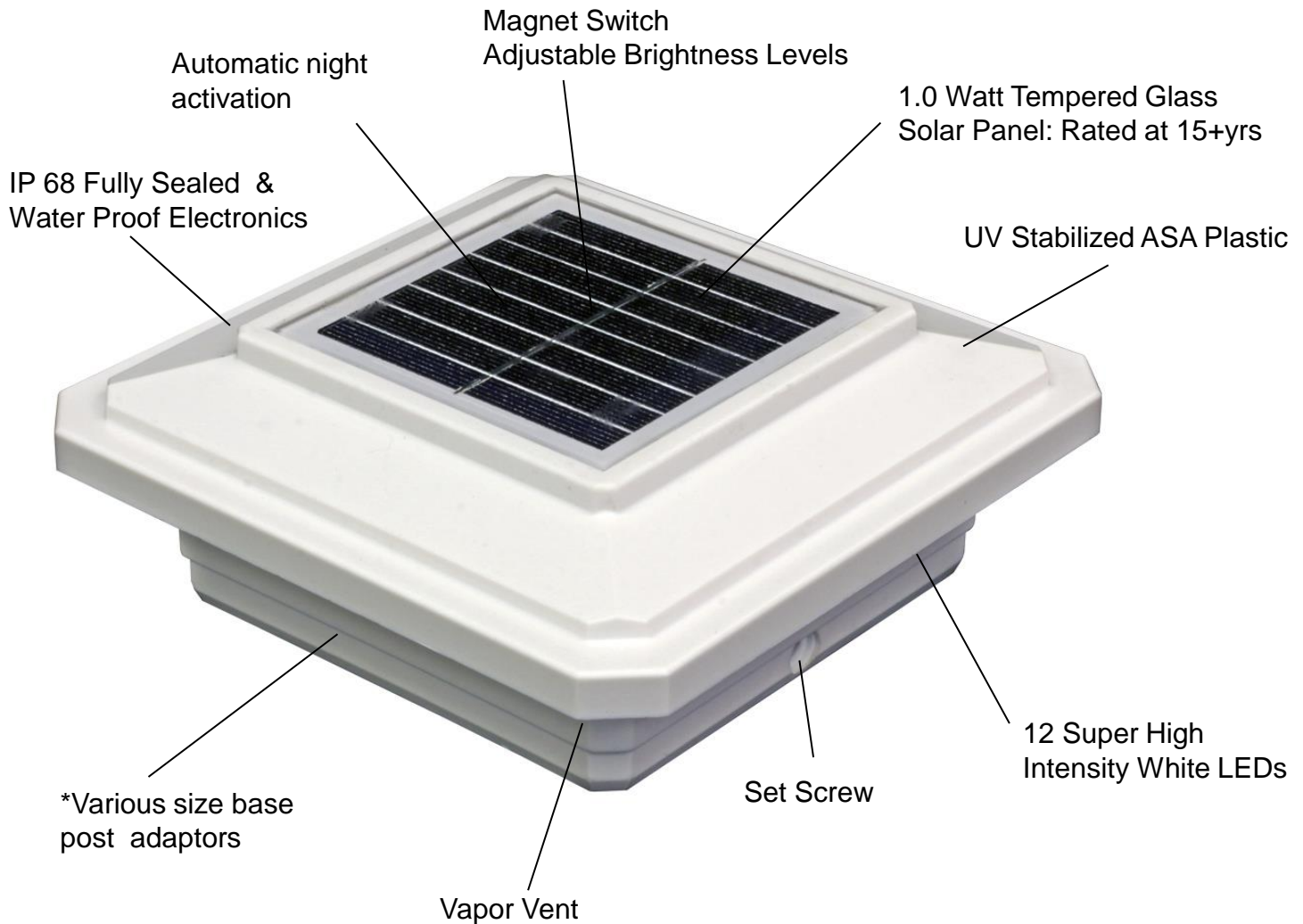

PATENTED DESIGN



Copyright Protected Design



4-Season Rated

**ULTRA BRIGHT**  
TECHNOLOGIES

Ultra Bright Tech  
P.O. Box 414  
105 W. Simon St.  
Laotto, IN 46763

Phone: 260-918-2758  
Fax: 260-918-3540  
E-mail sales@ultrabrighttech.com  
Web: www.ultrabrighttech.com

# BASE OPTIONS AVAILABLE FOR THIS MODEL

Ultra Bright Base Option	Fits General Post Size	* Various Popular Brands / Series
UBT-400-350-X	4.00" x 4.00" Inch	VINYL/Generic 4x4 Post Covers
UBT-400-350-X	3.50" x 3.50"	WOOD/Generic 4x4 Post Covers

UBT-400-350-X

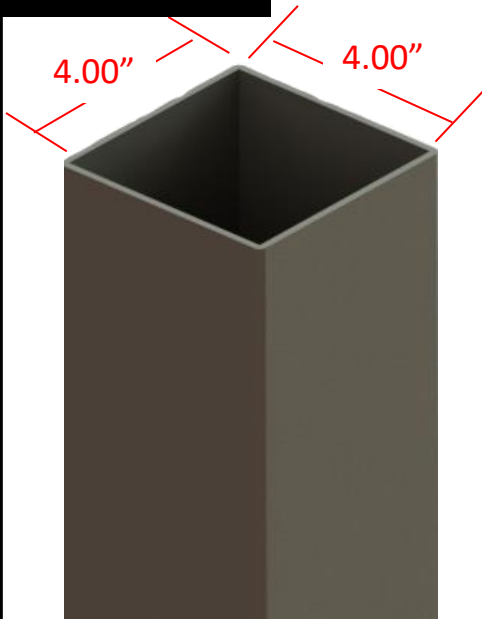

Fits General 4x4 Vinyl Post Covers

**UBT-400-350** Post cap, without the included base adaptor will fit vinyl styles & brands of 4.00x4.00" post covers: (Sharp or beveled corners)

Actual shape & profile designs will vary with different brands. This is a general reference only.

UBT-400-350-X



Fits General 4x4 Wood Post Covers (3.5"x3.5" Actual)

**UBT-400-350** Base Adaptor will fit all of 4.00x4.00" wooden post covers, with true dimensions of 3.50"x3.50": (Sharp or beveled corners)

This is a general reference only.

Dimensions: (In.)

# SOLAR POST CAP

**ULTRA BRIGHT**  
TECHNOLOGIES

Phillips Screwdriver

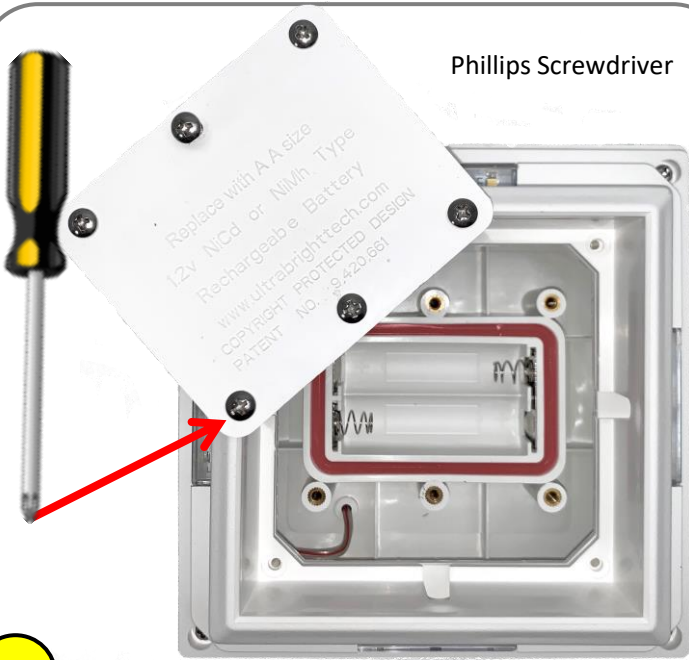

Use a screwdriver to remove the battery cover & connect the battery: **NOTE:** Align the connectors before joining.

Phillips Screwdriver



Ensure the silicone pad is under the battery cover and reinstall the cover in place. Tighten all screws to ensure a waterproof seal.

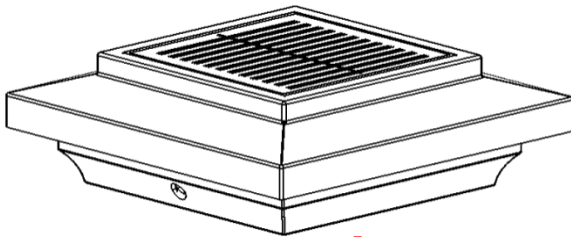

Place the solar Post Cap on the post. Mark both holes on the post. Use an appropriate drill bit to make a small pilot hole for the provided screws.

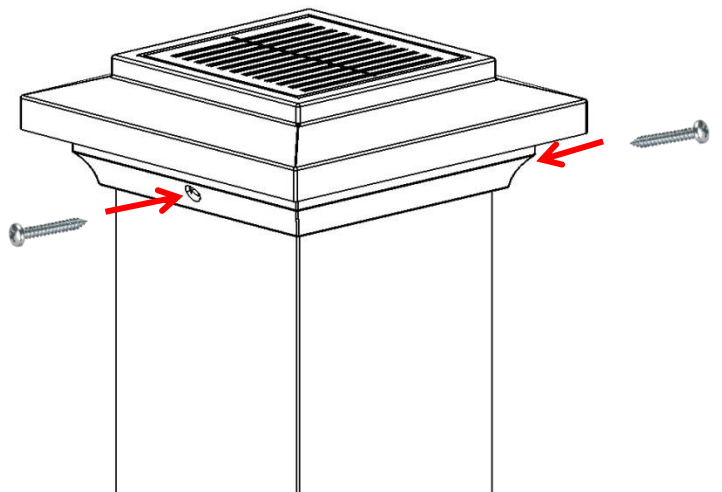

Use the provided screws to secure your solar post light to the post.

**ULTRA BRIGHT**  
TECHNOLOGIES

Ultra Bright Tech  
P.O. Box 414  
105 W. Simon St.  
Laotto, IN 46763

Phone: 260-918-2758  
Fax: 260-918-3540  
E-mail: sales@ultrabrighttech.com  
Web: www.ultrabrighttech.com



# SOLAR POST CAP



## BRIGHTNESS SWITCH

Wave the magnet over the solar panel at NIGHT until you find the activation area which changes the brightness level. This operation only works at NIGHT or in absence of light.

Swipe the magnet quickly across the solar panel activation area to change between brightness levels & OFF.

**NOTE:** In the OFF mode the battery will still charge during the daytime, however at night the light will NOT turn on.

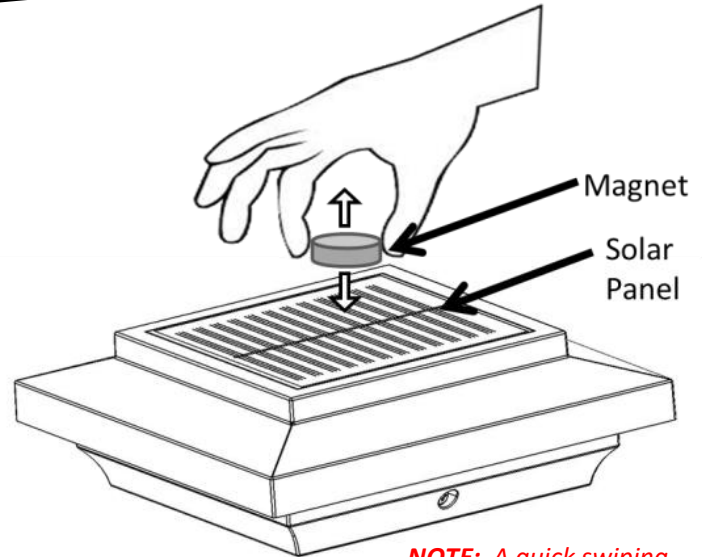

**NOTE:** A quick swiping motion across the solar panel works best!

LED BRIGHTNESS LEVEL	RUN TIME BASED ON BATTERY CHARGE LEVEL				
	100%	80%	60%	40%	20%
7	10	8	6	4	2
6	13	10	8	5	3
5	15	12	9	6	3
4	20	16	12	8	4
3	29	23	17	11	6
2	50	40	30	20	10
1	100	80	60	40	20
OFF	OFF	OFF	OFF	OFF	OFF

**NOTE: RUN TIMES ARE BASED ON A FULL CHARGE: MANY FACTORS MAY PREVENT A FULL CHARGE SEE BELOW**

- **TESTING:** Place entire light in a dark room. Light should turn on, if not, swipe the magnet over the solar panel until light turns on.
- Run times will vary significantly based on factors such as; Sun Exposure, Season, Angle of Sunlight, Geographic Location, Shading, Installed Location/Position, Battery Condition, and most importantly, the Brightness Setting in comparison to the yearly season.
- The following run times should only be used as a general reference and are not guaranteed. Consider your local environment
- Lower brightness settings use less power and leave more reserve power for cloudy days where less recharging takes place.

**PRODUCT & WARRANTY REGISTRATION: Visit [www.ultrabrighttech.com/registration](http://www.ultrabrighttech.com/registration)**

### Ultra Bright Technologies 1-Year Limited Warranty

The retailer warrants the Solar Lights to be free from defects in workmanship and material present at time of shipment from the factory for a period of one year after the date of purchase by the original purchaser. We agree to correct such defects without charge or at our option replace with a comparable or superior model if the product is returned to the retailer. To obtain warranty service, you must present a copy of the receipt as proof of purchase. All costs of removing and reinstalling the product are your responsibility. Damage to any part such as by accident or misuse or improper installation or by affixing any accessories, is not covered by this warranty. There is no other express warranty. The retailer hereby disclaims any and all warranties, including but not limited to, those of merchantability and fitness for a particular purpose to the extent permitted by law. The duration of any implied warranty, which cannot be disclaimed, is limited to the time period as specified in the express warranty. Some states do not allow limitation on how long an implied warranty lasts, so the above limitation may not apply to you. The retailer shall not be liable for incidental, consequential, or special damages arising out of or in connection with product use or performance except as may otherwise be accorded by law. Some states do not allow the exclusion of incidental or consequential damage, so the above exclusion or limitation may apply to you. This warranty gives specific legal rights, and you may also have other rights, which vary from state to state. This warranty supersedes all prior warranties.